

■ Stex 45 mounting plate MP-S M8 ZnNi

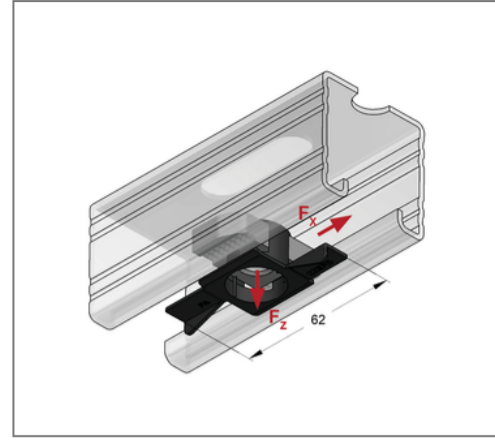
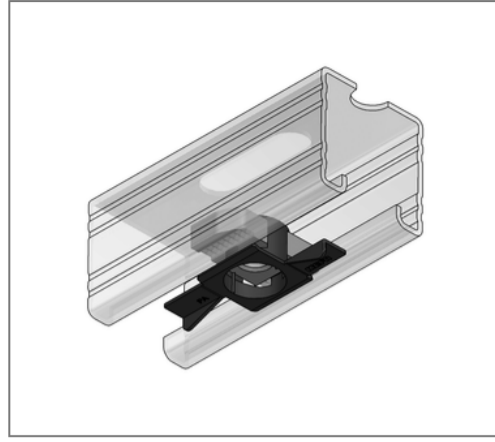
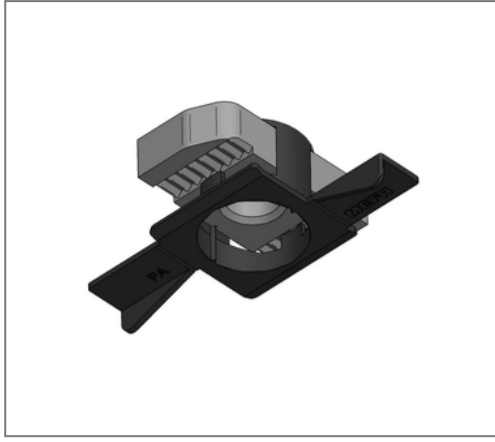

Commercial details

Part no.	0818104
EAN/GTIN	4250928466570
Packing unit	50 pcs
Quantity unit	pcs
Weight	0,0462 kg/pc
Product group	02-081
Price unit	1

QR code



Certification



Technical data

Material	Steel
Material type	S235
Surface	Zinc-Nickel
material cage	Plastic
materialname cage	Polyamide 6

Product details

Loading capacity	see loads in the catalogue
Length	38 mm
Width	62 mm
Thread	M8
Profile type	45
Shape	pivoted