

■ Console Stex 35/42 L= 225 mm Plate vertical galv.

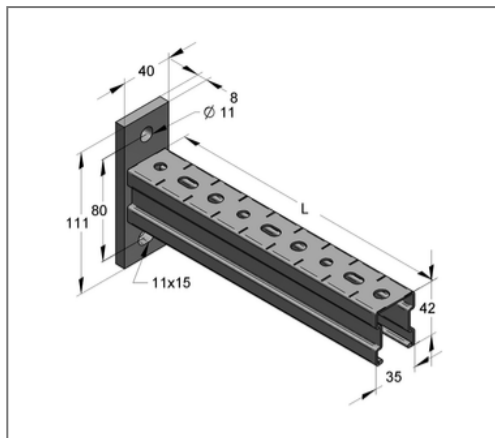

Commercial details

Part no.	12760225
EAN/GTIN	4250928424532
Packing unit	20 pcs
Quantity unit	pcs
Weight	0,630 kg/pc
Product group	02-127
Price unit	1

QR code



Specification

Application area	Console for the production of cantilever structures for the support of suspended and standing pipe loads.
------------------	---

Technical data

Material	Steel
Surface	galvanized

Product details

Width plate	40 mm
Length plate	111 mm
Hole distance	80 mm
Plate thickness	8 mm
Width profile	35 mm
Profile height	42 mm
Length console L	225 mm
Elongated hole plate	11x15 mm
load F1	2,78 kN
load F2	1,39 kN
load q0	12,35 kN/m
Profile thickness	1,5 mm