

■ Console Stex 35/42 L= 450 mm Plate vertical galv.

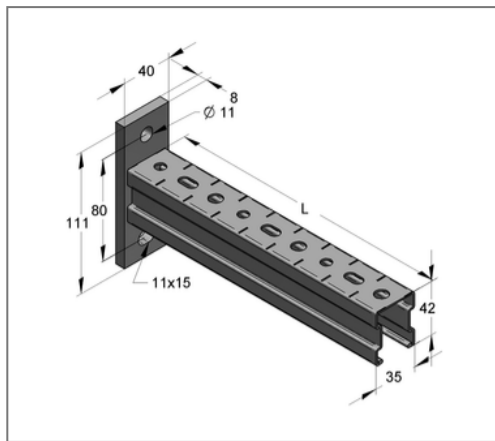

Commercial details

Part no.	12760450
EAN/GTIN	4250928424563
Packing unit	15 pcs
Quantity unit	pcs
Weight	0,997 kg/pc
Product group	02-127
Price unit	1

QR code



Specification

Application area	Console for the production of cantilever structures for the support of suspended and standing pipe loads.
------------------	---

Technical data

Material	Steel
Surface	galvanized

Product details

Width plate	40 mm
Length plate	111 mm
Hole distance	80 mm
Plate thickness	8 mm
Width profile	35 mm
Profile height	42 mm
Length console L	450 mm
Elongated hole plate	11x15 mm
load F1	1,39 kN
load F2	0,69 kN
load q0	3,09 kN/m
Profile thickness	1,5 mm