

## ■ Profile rail C-profile 45 / 26 / 1,5 mm L= 6 m pre-galv.

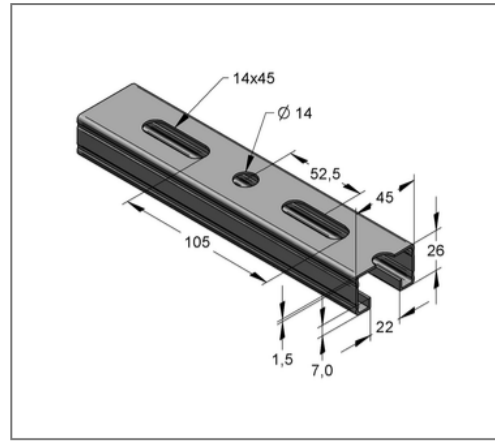
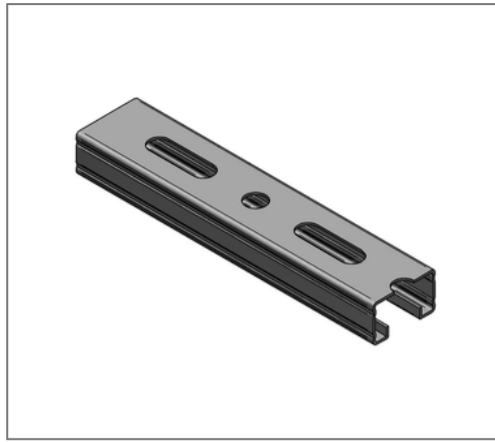

### Commercial details

Part no.	08202662
EAN/GTIN	4250928420749
Packing unit	60 m
Bundle	600 m
Quantity unit	m
Weight	1,34 kg/m
Product group	02-082
Price unit	1

### QR code

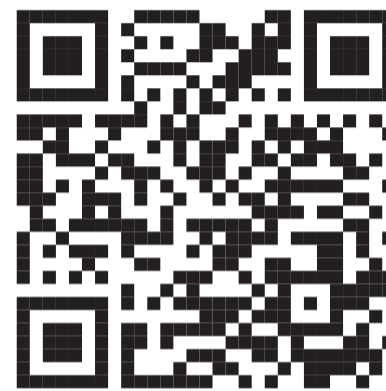

### Certification



### Specification

Application area	Medium weight mounting rail with quick connection option.
Specification	C-profile rail, perforated and toothed
Type of attachment	form-locking connections and shear hole haunch connections

### Technical data

Material	Steel
Material type	S250
Surface	pre-galvanized

### Product details

Width	45 mm
Height	26 mm
Thickness	1,5 mm
Length	6 m
Hole-Ø	14,00 mm
Elongated hole	14x45 mm
Area (least cross section of the profile rail)	1,49 cm <sup>2</sup>
Axial angular impulse I <sub>y</sub>	1,42 cm <sup>4</sup>
Axial angular impulse I <sub>z</sub>	5,15 cm <sup>4</sup>
Grid dimension	105,0 mm
Rail slot width	22 mm
Centroid distance e <sub>o</sub>	1,34 cm
Centroid distance e <sub>u</sub>	1,26 cm
Centroid distance e <sub>z</sub>	2,25 cm
Elastic limit	250 N/mm <sup>2</sup>

## Remark

Notice	Full bundles, only
Radius of inertia $i_z$	1,86 cm
Section modulus $W_Y$	1,06 cm <sup>3</sup>
Section modulus $W_Z$	2,29 cm <sup>3</sup>