

## ■ Profile rail C-profile 45 / 45 / 2,5 mm L= 3 m pre-galv.

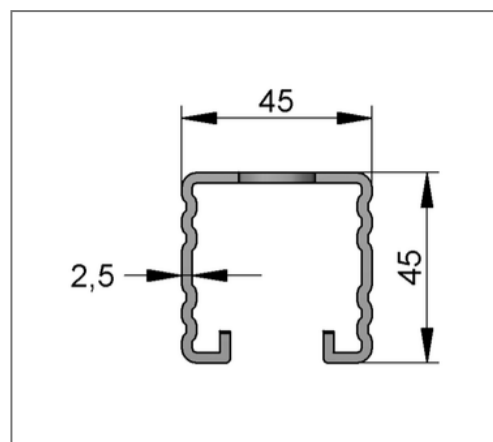
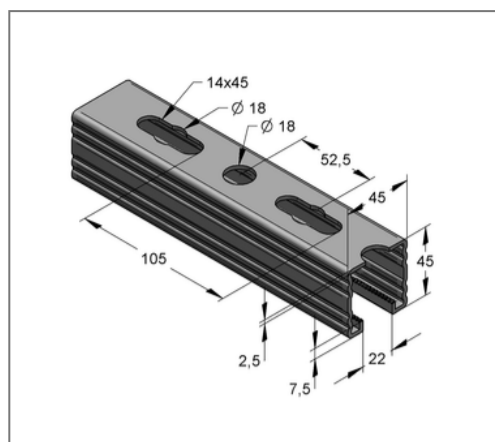

### Commercial details

Part no.	0820453251
EAN/GTIN	4250928448057
Packing unit	30 m
Bundle	180 m
Quantity unit	m
Weight	2,96 kg/m
Product group	02-082
Price unit	1

### QR code



### Certification



### Specification

Application area	Medium weight mounting rail with quick connection option.
Specification	C-profile rail, perforated and toothed
Type of attachment	form-locking connections and shear hole haunch connections

### Technical data

Material	Steel
Material type	S250
Surface	pre-galvanized

### Product details

Width	45 mm
Height	45 mm
Thickness	2,5 mm
Length	3 m
Hole-Ø	18,00 mm
Elongated hole	14x45 mm
Expansion elongated hole	18,0 mm
Area (least cross section of the profile rail)	3,53 cm <sup>2</sup>
Axial angular impulse I <sub>y</sub>	8,81 cm <sup>4</sup>
Axial angular impulse I <sub>z</sub>	12,69 cm <sup>4</sup>
Grid dimension	52,5 mm
Rail slot width	22 mm
Centroid distance e <sub>o</sub>	2,19 cm
Centroid distance e <sub>u</sub>	2,31 cm
Centroid distance e <sub>z</sub>	2,25 cm

## Remark

Notice	Full bundles, only
Radius of inertia $i_y$	1,58 cm
Radius of inertia $i_z$	1,90 cm
Section modulus $W_y$	3,80 cm <sup>3</sup>
Section modulus $W_z$	5,64 cm <sup>3</sup>