

■ Profile rail C-profile 45 / 45 / 2,5 mm L= 6 m hot-dip galv.

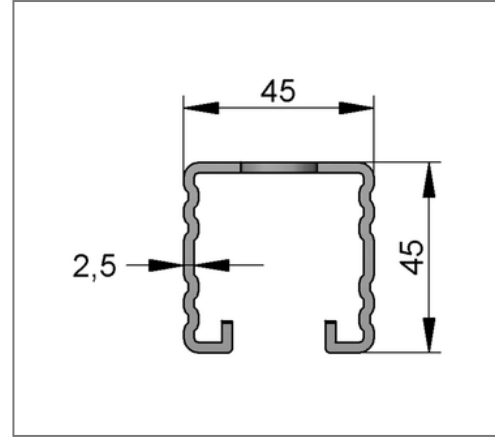
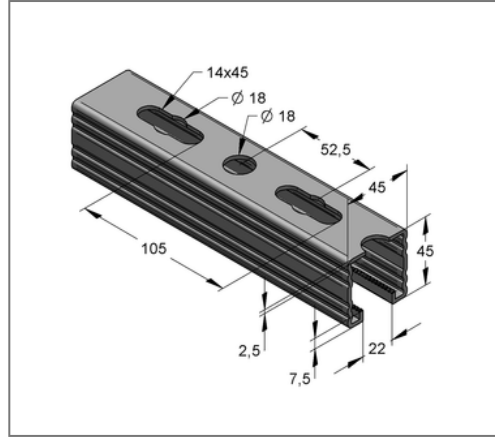
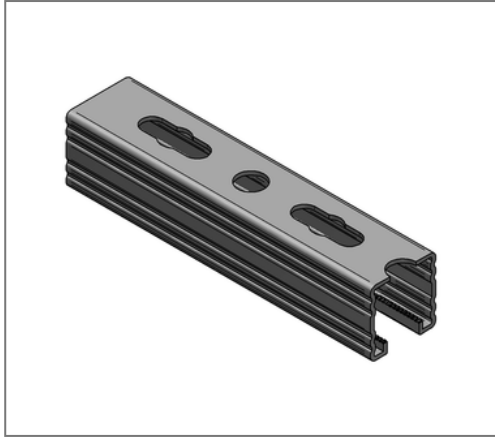

Commercial details

Part no.	0820456252
EAN/GTIN	4250928448101
Packing unit	30 m
Bundle	360 m
Quantity unit	m
Weight	3,21 kg/m
Product group	02-082
Price unit	1

QR code



Certification



Specification

Application area	Medium weight mounting rail with quick connection option.
Specification	C-profile rail, perforated and toothed
Type of attachment	form-locking connections and shear hole haunch connections

Technical data

Material	Steel
Material type	S235
Surface	hot-dip galvanized

Product details

Width	45 mm
Height	45 mm
Thickness	2,5 mm
Length	6 m
Hole-Ø	14,00 mm
Elongated hole	14x45 mm
Expansion elongated hole	18,0 mm
Area (least cross section of the profile rail)	3,53 cm ²
Axial angular impulse I_y	8,81 cm ⁴
Axial angular impulse I_z	12,69 cm ⁴
Grid dimension	52,5 mm
Rail slot width	22 mm
Centroid distance e_o	2,19 cm
Centroid distance e_u	2,31 cm
Centroid distance e_z	2,25 cm

Remark

Notice	Full bundles, only
Radius of inertia i_y	1,58 cm
Radius of inertia i_z	1,90 cm
Section modulus W_y	3,80 cm ³
Section modulus W_z	5,64 cm ³