

## ■ Head profile C-profile 45/60 Height 60 mm Elongated hole 17,5x13 mm

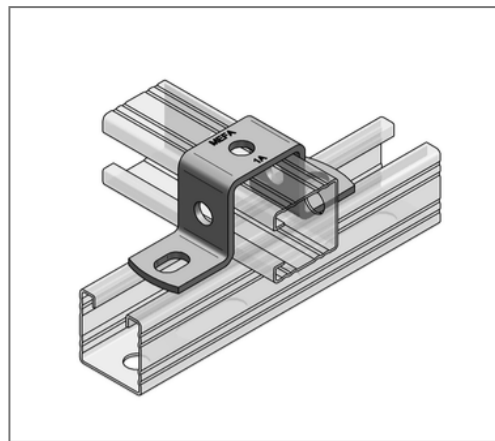
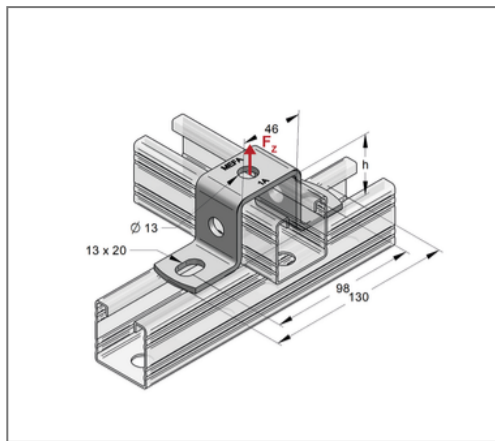
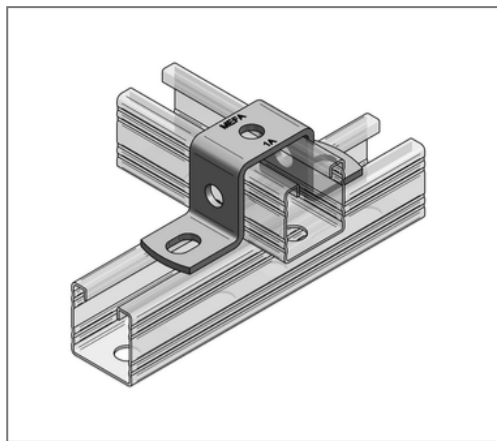

### Commercial details

Part no.	0816253
EAN/GTIN	4250928420244
Packing unit	25 pcs
Quantity unit	pcs
Weight	0,253 kg/pc
Product group	02-081
Price unit	1

### QR code



### Specification

Application	Connecting component for fixing two crossing area
	profile rails.

### Technical data

Material	Steel
Material type	S235
Surface	galvanized

### Product details

load $F_Z$	3,5 kN
Height h	60 mm
Length	130 mm
Length inside	45 mm
Width material	35 mm
Material thickness	4 mm
Elongated hole	13x17,5 mm
Profile type	45/60
Hole distance	98 mm
Terminal hole	13 mm