

## ■ Holder Double C-profile 45 vertical for Double-C-profile 45/90 hot-dip galv.

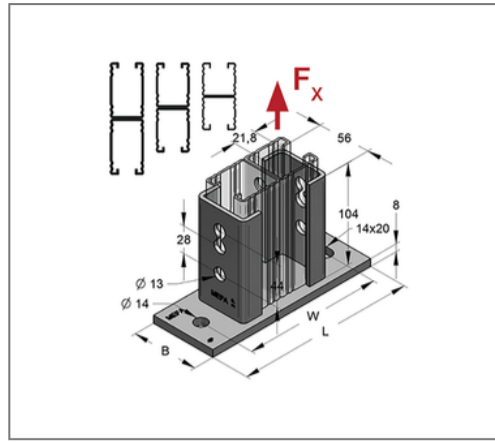
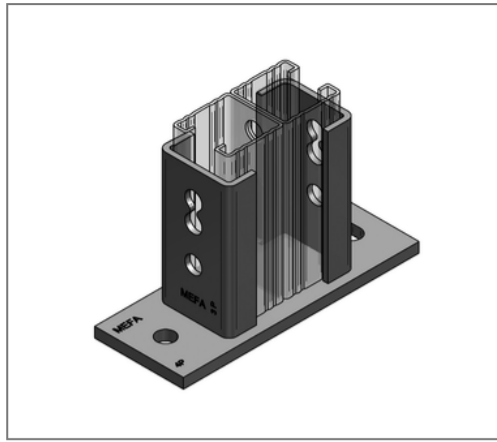

### Commercial details

Part no.	08120952
EAN/GTIN	4250928447944
Packing unit	10 pcs
Quantity unit	pcs
Weight	1,40 kg/pc
Product group	02-081
Price unit	1

### QR code

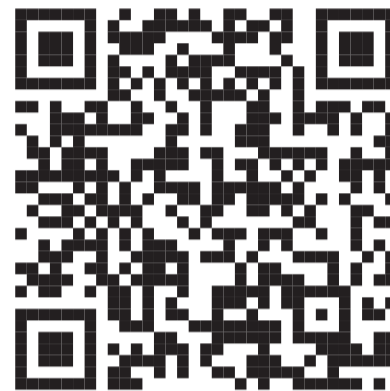

### Certification



### Specification

Application area	for fixation of profile rails on construction
Profile type	45/90
Profile	Double-C-profile
Type of attachment	on the building structure

### Technical data

Material	Steel
Material type	S235
Surface	hot-dip galvanized

### Product details

load $F_x$	13,7 kN
Length plate L	186 mm
Width plate B	70 mm
Plate thickness	8 mm
Alignment of plate	vertical
Hole distance W	144 mm
max. profile height	90 mm

### Remark

Notice Bei feuerverzinkten Teilen sind Maßabweichungen bis zu 1 mm möglich.