

■ Console C-profile 45/45 L= 630 mm Plate vertical galv.

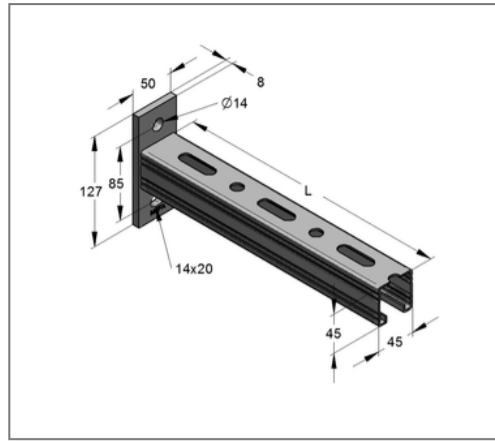
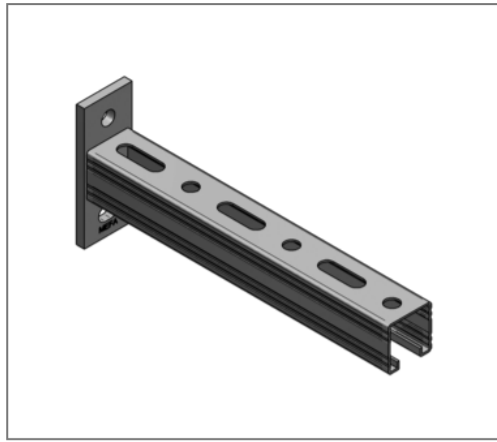

Commercial details

Part no.	180450630
EAN/GTIN	4250928448279
Packing unit	5 pcs
Quantity unit	pcs
Weight	1,92 kg/pc
Product group	02-083
Price unit	1

QR code



Specification

Application area	Console for the production of cantilever structures for the support of suspended and standing pipe loads.
------------------	---

Technical data

Material	Steel
Surface	galvanized

Product details

Width plate	50 mm
Length plate	127 mm
Hole distance	85 mm
Plate thickness	8 mm
Width profile	45 mm
Profile height	45 mm
Length console L	630 mm
Elongated hole plate	14x20 mm
load F1	1,66 kN
load F2	0,82 kN
load q0	2,63 kN/m
Profile thickness	2 mm